

SUNPALON 10mm PANEL (Roof type detail) Scale : 1/3 (A3)

 <p>SUNPALON 4Wall R-Structure 10mm Panel Max Length : 11.9m</p>						
	PC Joiner	PC End-Cap	T-Fastener	AL Sealing Strip	35*45*2T SP AL. F-BAR	AL Span Bar

Sunpalon Panel

Accessories

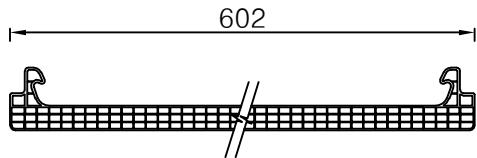
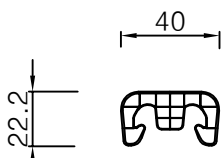
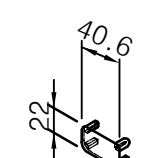
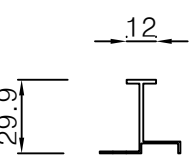
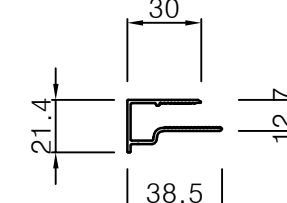
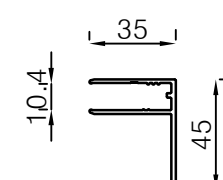
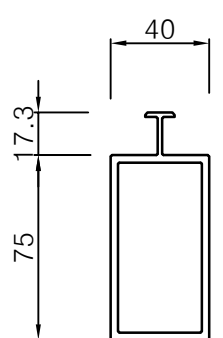
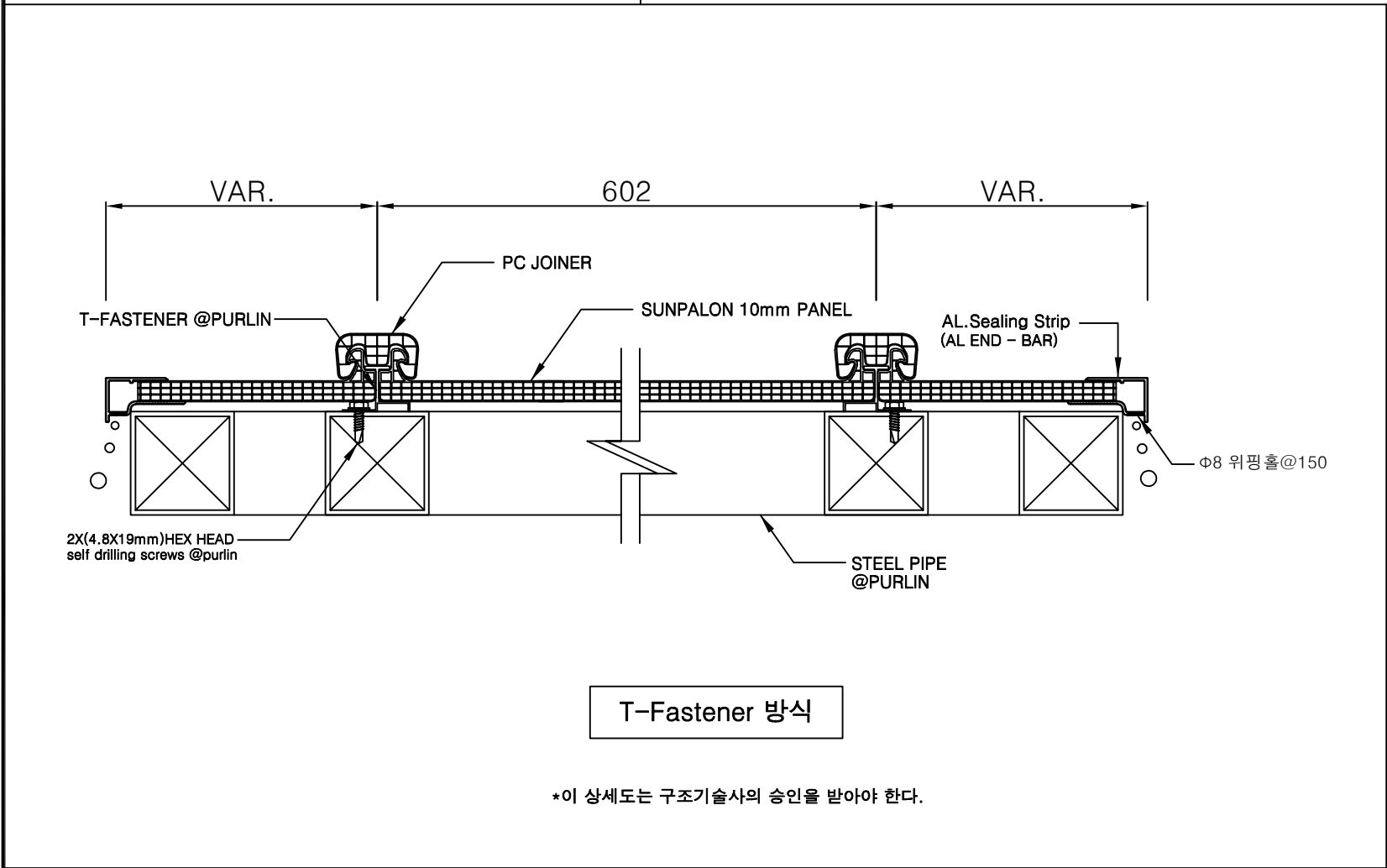

Section Detail

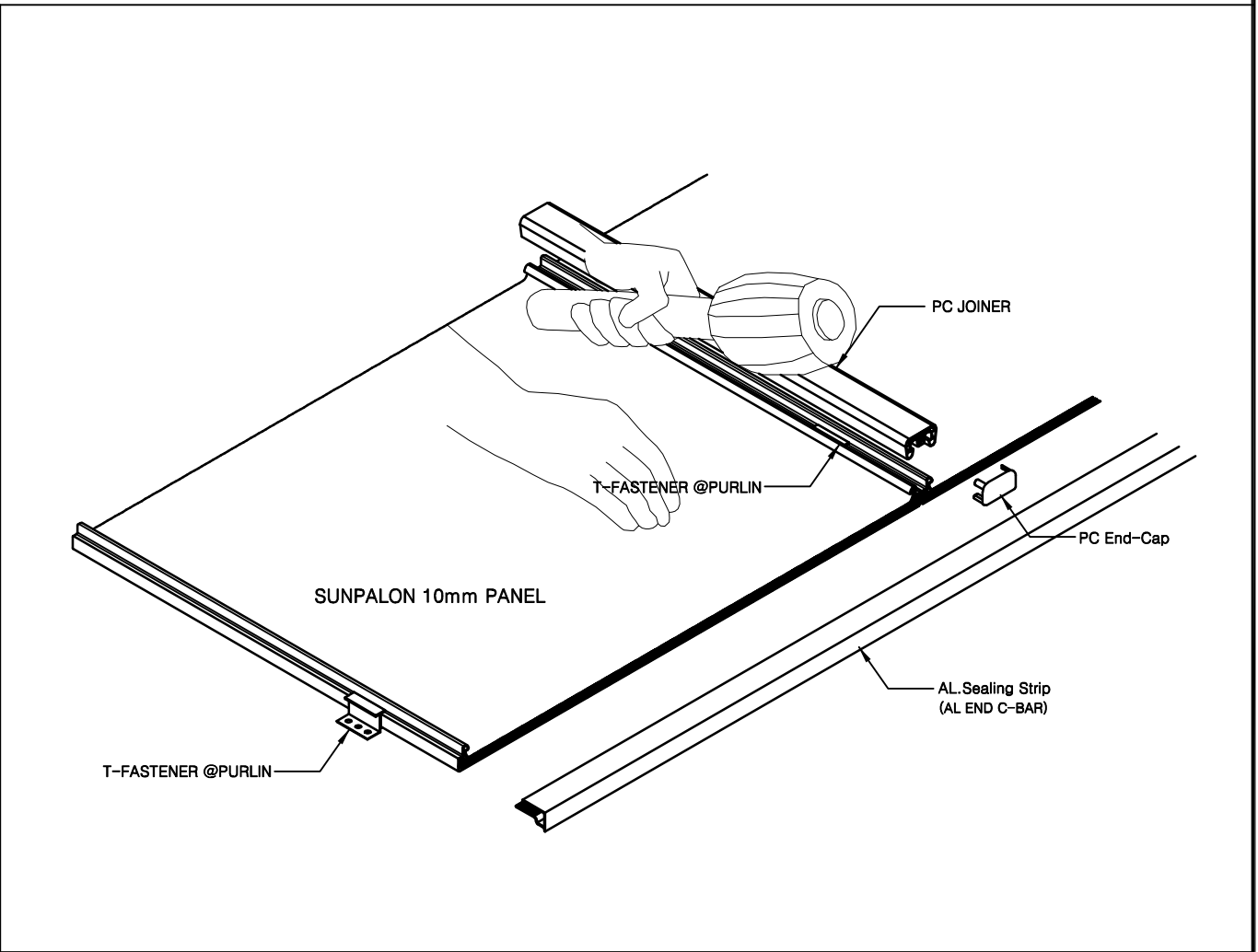

제품 조립도



주 소 : 경기도 화성시 서신면 마도로 30-7  
 TEL : 031 - 356 - 4443, FAX : 356 - 1443  
 www.starpoly.co.kr  
 E-Mail : starpolychem@naver.com

- NOTE
1. 현장 상황을 고려하여 시공할 것.
  2. 구조/안전을 확인 후 시공할 것.

SUNPALON U-PANEL SYSTEM (ROOF)

사업명 (PROJECT)			
도면명 (TITLE)			
일자 (DATE)	축척 (SCALE) A3 1/3	도면번호 A-	